

INCLUDED ACCESSORIES

Remote control and two AAA batteries

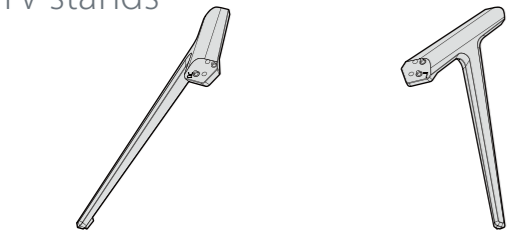

TV stands



M5 screws (4 pcs.)

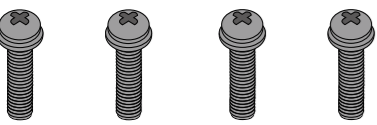

Power cord

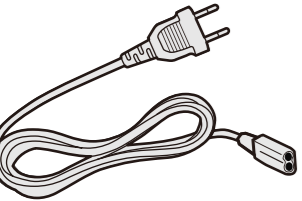

WHAT YOU NEED (not included)

Phillips screw driver

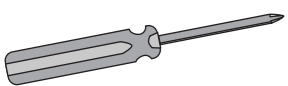

Wireless router* (needed for streaming)

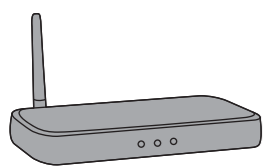

Internet connection* (needed for streaming)



* Subscription or other payment may be required to access certain content.

FIND YOUR USER GUIDE ONLINE!
Go to <http://www.lg.com/us>.
Enter the TV model number in the Search By Product field, then press ENTER.

STOP
Do not plug your power cord in until all other devices have been connected.

1 START HERE

How do I attach the stands to my TV? (not for wall mounting)

You'll need: Soft surface and Phillips screwdriver.

A Carefully place your TV face-down on a cushioned, clean surface.

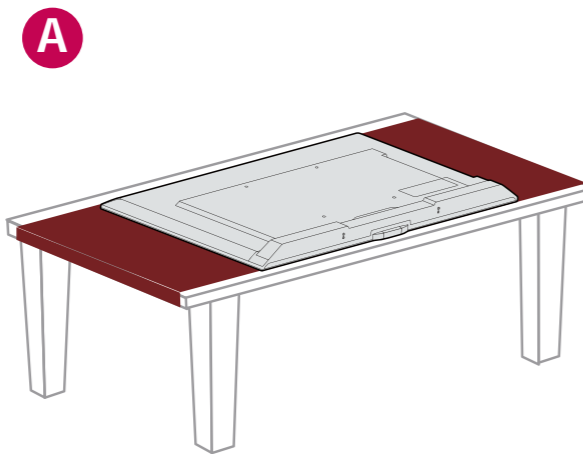

B Align the the TV stands with the screw holes on the bottom of the TV, then secure the stands to the TV with the four provided screws.

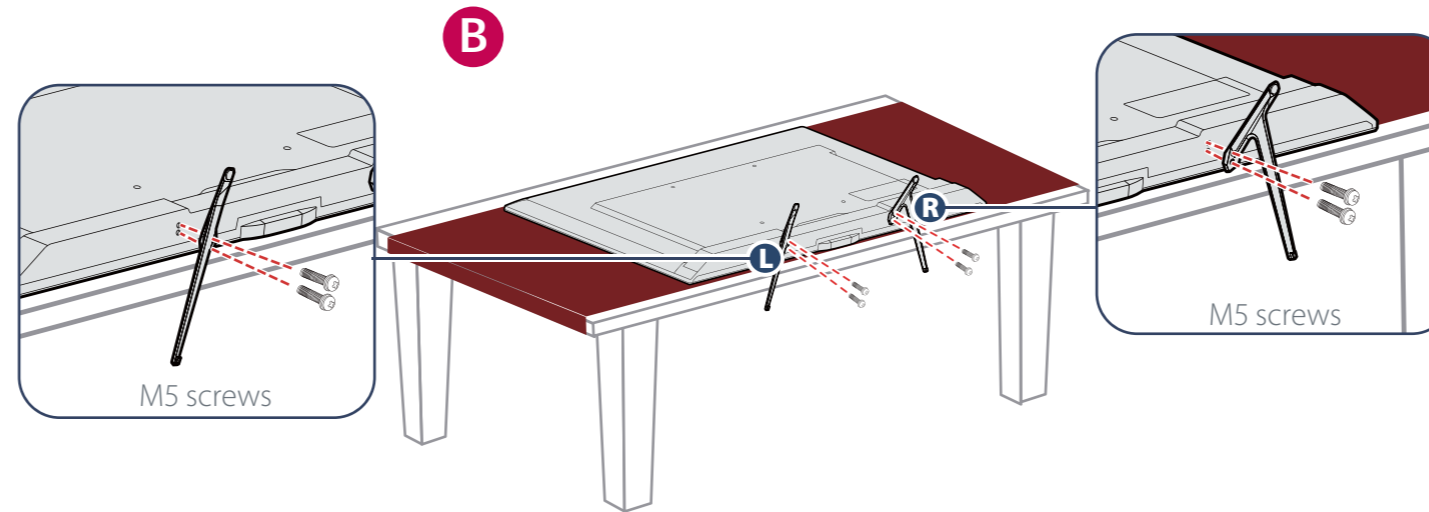

WALL MOUNT

How do I prepare my TV for wall mounting? (not for use with a TV stand)

You'll need: Soft surface and Phillips screwdriver.

A Carefully place your TV face-down on a cushioned, clean surface.
B See the instructions that came with your wall mount for more information about how to correctly mount your TV.

OR

A

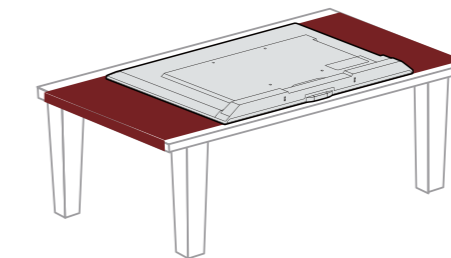

B

Your TV has four VESA mounting holes on the back. If you attach a wall-mount bracket to the back of your TV, the bracket must be securely attached, using all four holes. If you do not use all four mounting holes, your TV may fall and cause property damage or personal injury. See the documentation that came with your wall mount for complete mounting instructions.

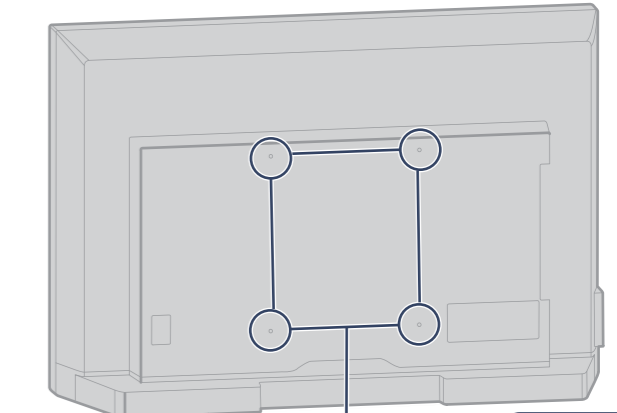

VESA Mounting Pattern
VESA mount (mm): 400 x 200 - M6 Type screws (not included)



FEATURES

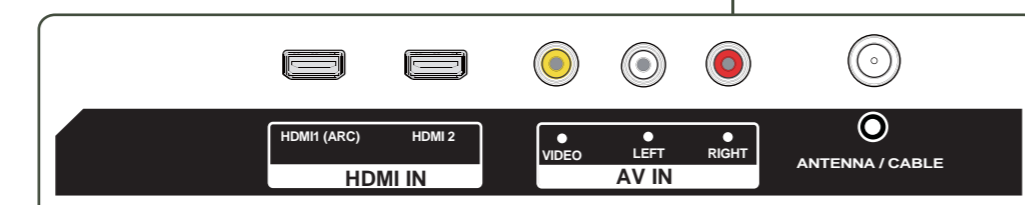
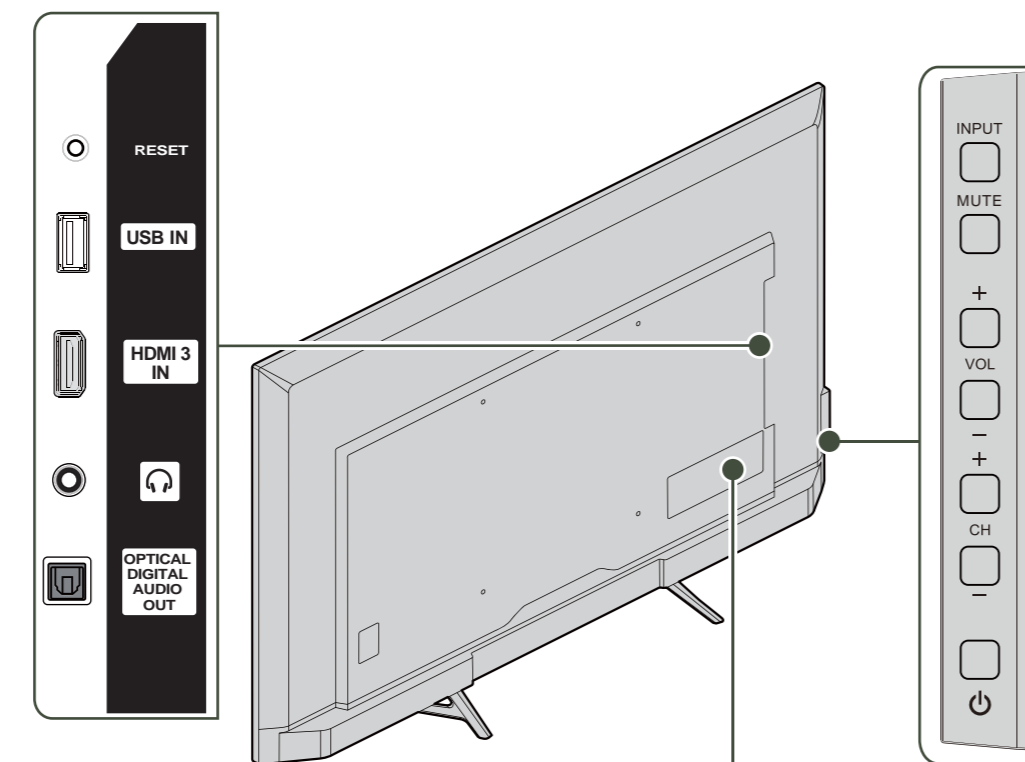
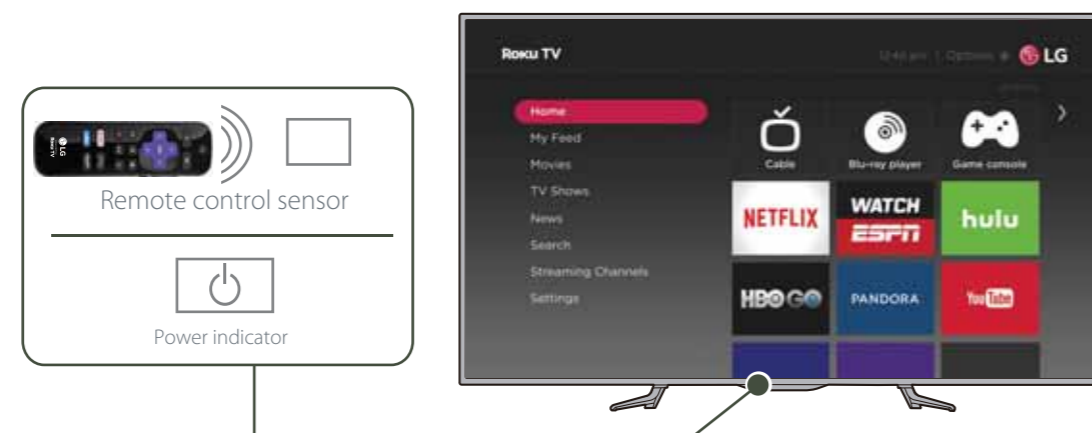

Before using your new product, please read these instructions to prevent any damage.

2 MAKING CONNECTIONS

How do I watch TV (cable, satellite, or antenna) or connect a device such as a DVD or Blu-ray disc player, game console, or tablet?

WHICH CABLES DO YOU HAVE?

HDMI (BEST)
Best video quality

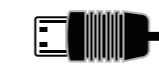

Multi-purpose jacks: You can plug any device that uses HDMI into any HDMI jack. However, certain devices must be connected to the ARC jack. See the instructions that came with your ARC-enabled device for more information.

AV (GOOD)

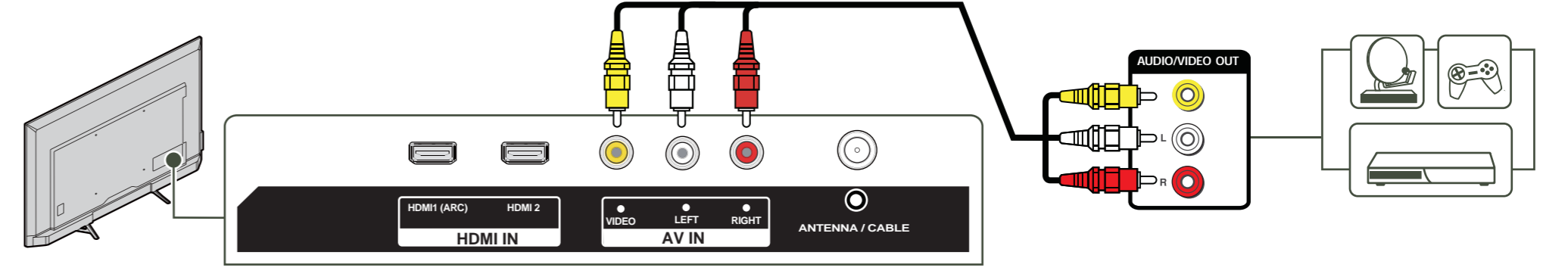
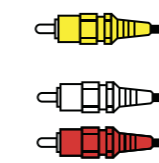

COAXIAL (GOOD)

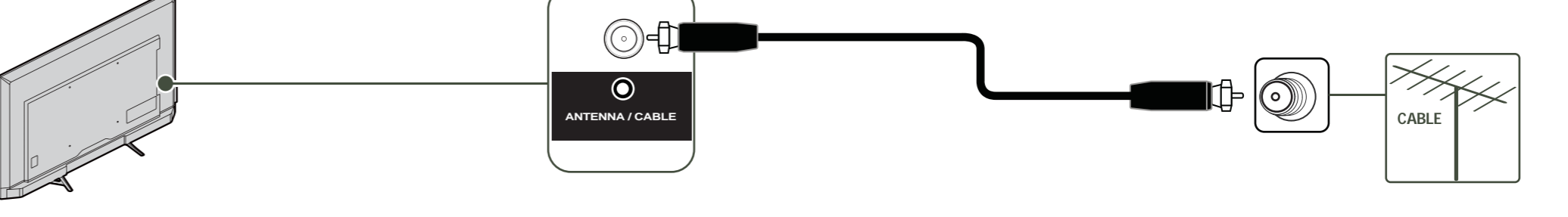

3 CONNECTING AUDIO DEVICES

USING DIGITAL AUDIO

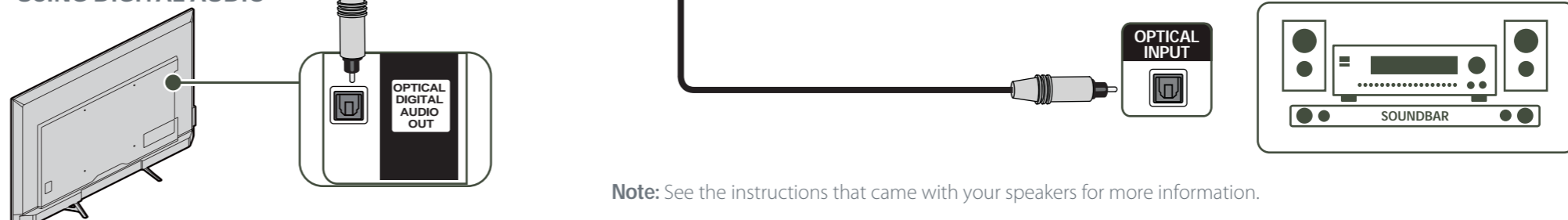

Note: See the instructions that came with your speakers for more information.

4 TURNING ON MY TV

When can I turn on my TV?

WHEN YOUR TV IS IN PLACE:

- 1 Plug the power cord into the **AC IN** jack on the back of your TV, then plug the other end into a power outlet.
- 2 Remove the remote control cover and install the batteries.
- 3 Press  (power) on your remote control.
- 4 Follow the on-screen instructions.

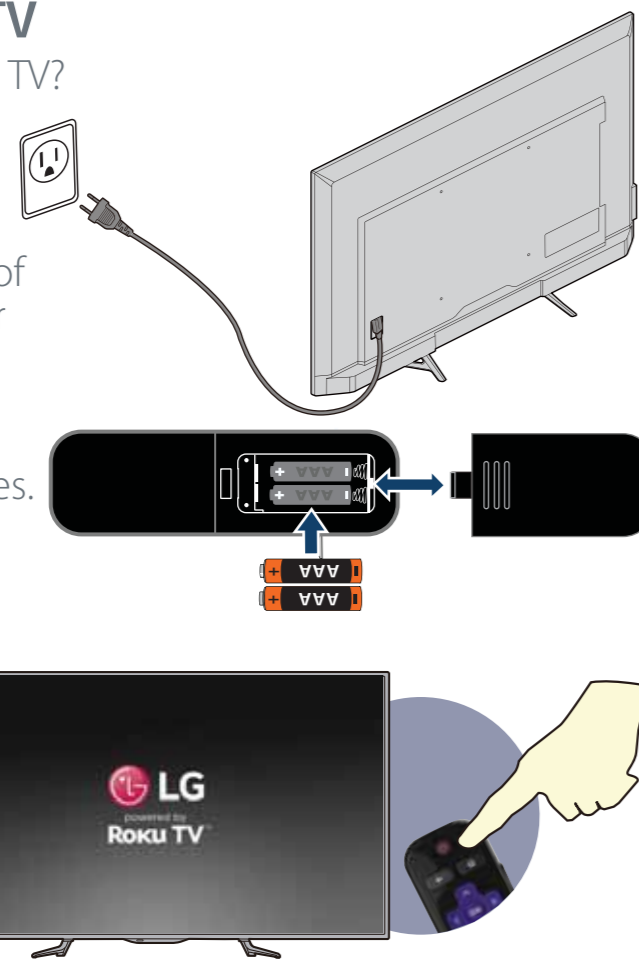

5 COMPLETE GUIDED SETUP (OPTIONAL)

Establish your network connection.

- 1 Your TV will automatically detect your wireless network, so have your network name and password handy and follow the easy on-screen setup.
- 2 After it is connected, your TV will automatically update with the latest software, and you can immediately start streaming entertainment.
- 3 When connected to the Internet, your new Smart LG TV powered by Roku TV automatically receives regular software updates in the background, continually improving your experience.
- 4 If you aren't ready to connect your TV to a wireless network, you can still use it as a regular TV.

And setup is done ... congratulations!

- 1 Continue using the remote to personalize your Home screen and channel line-up, stream movies, and much more.
- 2 If you have an antenna or cable connected, just click the **Tuner** tile to watch broadcast TV channels. The fun has just begun!
- 3 When prompted during Guided Setup, use the unique code your TV generates to link your TV to your new Roku account at <https://my.roku.com/link>.
- 4 (Optional) While Roku accounts are free, enter a valid credit card number to make renting and purchasing entertainment from the Roku Channel Store fast and convenient.

6 OPTIONAL

Watching local broadcast TV.
How do I scan for channels?

If you connected a cable or satellite box, skip this step.

If you connected your TV to an antenna or cable wall jack (no box):

- 1 When the setup wizard is complete, select the **Antenna TV** tile  from the Home screen.
- 2 Follow the on-screen instructions.
- 3 Whenever you want to watch TV, select this tile.



TROUBLESHOOTING

Having trouble completing the guided setup?

Don't worry, it's usually an easy fix.

If you cannot see a picture on your TV

- Make sure that your TV and the device you want to watch (cable box, Blu-ray player, game console, etc.) are turned on and plugged into a working wall outlet.
- Make sure that your power cable is connected.

If you cannot connect to your wireless home network during guided setup

- Make sure that the correct wireless network name is selected.
- Make sure that the wireless network password is correctly entered (password is case sensitive).
- Improve wireless signal by rotating the router slightly (even a few inches can help).

If you cannot hear sound

- Make sure that the TV volume is turned up and not on mute.
- Try only the TV speakers by disconnecting any connection to audio devices (like headphones or audio video receivers).

If the TV remote control isn't working

- Remove any obstruction and point the remote at the TV's remote control sensor (see Features).
- Try a fresh set of batteries.
- If the status light on the front of your TV flashes once each time you press a remote button, the problem is not with the remote.
- Unplug the TV and plug it back in.

ONE-YEAR LIMITED WARRANTY

NEED ADDITIONAL HELP?

See your online **User Guide!** This comprehensive guide includes everything from basic how-to steps to more advanced features. A copy of your *User Guide* is not provided in the box but is available online.

FOR ADDITIONAL HELP

For customer service, call:
800-547-1516 (U.S.)

©2015 LG. All rights reserved.
Made in China.

CONNECTING BRINGS OUT YOUR TV'S FULL POTENTIAL!

You'll have access to more than 2,000 streaming channels.

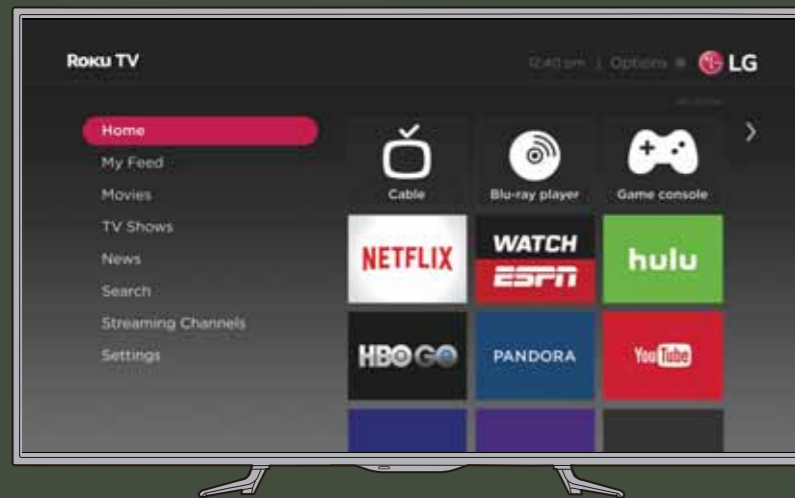

Make any night a movie night

More than 35,000 movies to choose from, across all major streaming movie channels like Netflix, Amazon Instant Video, Google Play, HULU, and more.*

Get in the groove

Stream music from one of 85 music channels like Pandora, VEVO, and Spotify. Access your entire MP3 collection instantly with Amazon Cloud Player or the Roku Media Player.

Explore your passions

In addition to popular streaming channels like HBO GO, NFL Now, PBSKids, and FOXNOW, your Smart LG TV powered by Roku TV also offer hundreds of streaming channels to fuel your passions – including fitness, cooking, religion, outdoors, International programming, and much more.

Enjoy FREE trials of popular channels

Your Smart LG TV powered by Roku TV comes loaded with special offers, including free trials from popular streaming channels like Amazon Instant Video, Netflix, HULU, Spotify, DailyBurn Fitness, and many more.

*Subscription or other payment may be required to access certain channels. Content may not be available in all areas in which LG Smart TVs powered by Roku TV are sold, and channel availability is subject to change.

ROKU, ROKU TV, and the ROKU logo are trademarks and the property of Roku, Inc. Other channel logos, brand, and product names are trademarks or registered trademarks of their respective holders.

USING YOUR REMOTE CONTROL

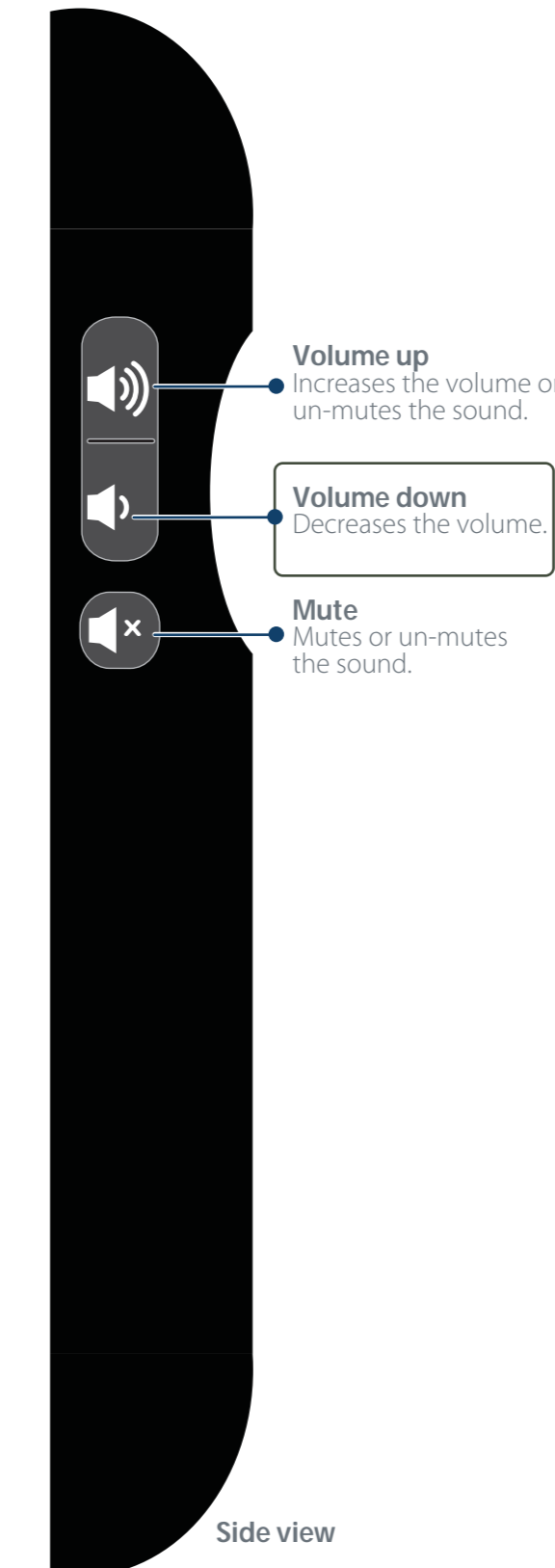

Using Your Cable Set-top Box or Satellite Receiver Remote as a Universal Remote.

If you prefer to use your cable set-top box or satellite receiver remote as a Universal Remote, please refer to the manual that your cable or satellite service provided. It will include instructions on how to program their remote to your television. You can find codes that work with your TV and the most common cable and satellite provider's universal remote control at www.roku.com/universalremote.